

CUSTOMER NAME \_\_\_\_\_  
CONTACT \_\_\_\_\_  
DATE \_\_\_\_\_

**1 CAP STYLE: O25 - CASUAL STRUCTURED**

QUANTITY COLORWAY 1 : \_\_\_\_\_  
QUANTITY COLORWAY 2 : \_\_\_\_\_

STANDARD  
288 PC. MINIMUM  
72 PC. PER COLORWAY

**2 CAP DETAILS:**

COLORWAY 1 : [CLICK HERE FOR AVAILABLE COLOR SWATCHES](#)

COLORWAY 2 :

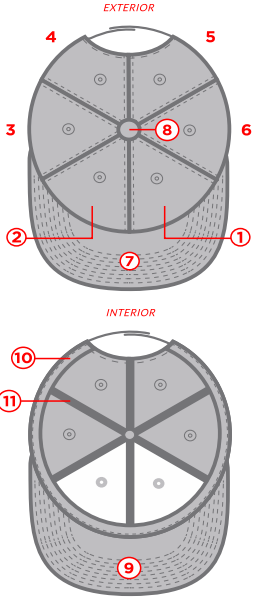

#	COLOR	FABRIC / MATERIAL	STITCH COLOR	EYELET COLOR
1.	_____	_____	_____	_____
2.	_____	_____	_____	_____
3.	_____	_____	_____	_____
4.	_____	_____	_____	_____
5.	_____	_____	_____	_____
6.	_____	_____	_____	_____
7.	_____	_____	_____	_____
8.	_____	_____	_____	_____
9.	_____	_____	_____	_____
10.	_____	_____	_____	_____
11.	_____	_____	_____	_____

#	COLOR	FABRIC / MATERIAL	STITCH COLOR	EYELET COLOR
1.	_____	_____	_____	_____
2.	_____	_____	_____	_____
3.	_____	_____	_____	_____
4.	_____	_____	_____	_____
5.	_____	_____	_____	_____
6.	_____	_____	_____	_____
7.	_____	_____	_____	_____
8.	_____	_____	_____	_____
9.	_____	_____	_____	_____
10.	_____	_____	_____	_____
11.	_____	_____	_____	_____

SUBLIMATION / SCREEN PRINT FILE NAME(S) : \_\_\_\_\_

METAL EYELETS  Y  N COLOR:  BLACK  
 SILVER  
 BRASS

ADDITIONAL NOTES

**3 VISOR**

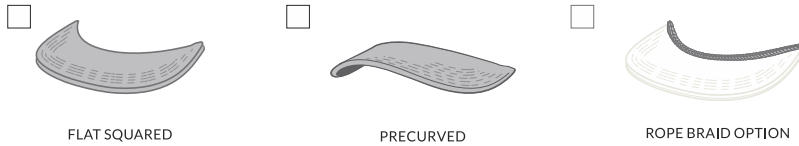

COLORWAY 1 / COLORWAY 2  
COLOR : \_\_\_\_\_ / \_\_\_\_\_

ADDITIONAL NOTES

**4 CLOSURE**

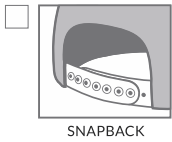

COLORWAY 1 / COLORWAY 2  
COLOR : \_\_\_\_\_ / \_\_\_\_\_

OR

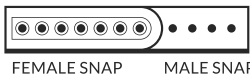

FEMALE SNAP COLOR: \_\_\_\_\_ / \_\_\_\_\_  
MALE SNAP COLOR: \_\_\_\_\_ / \_\_\_\_\_

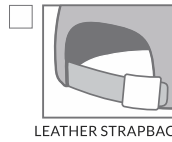

COLORWAY 1 / COLORWAY 2  
LEATHER COLOR

- BLACK
- LIGHT BROWN
- DARK BROWN
- WHITE

METAL CLASP COLOR  
 GOLD  
 SILVER  
 BRONZE

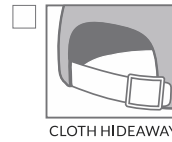

COLORWAY 1 / COLORWAY 2  
METAL CLASP COLOR

- GOLD
- SILVER
- BRONZE

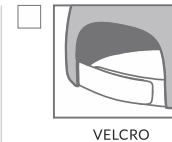

COLOR :  
COLORWAY 1 / COLORWAY 2

OR

LEFT COLOR: \_\_\_\_\_

RIGHT COLOR: \_\_\_\_\_

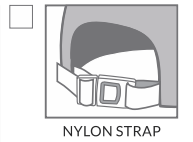

NYLON STRAP W/PLASTIC CLASP  
[BLACK ONLY]

**5 DECORATION DESIGN MAP :**

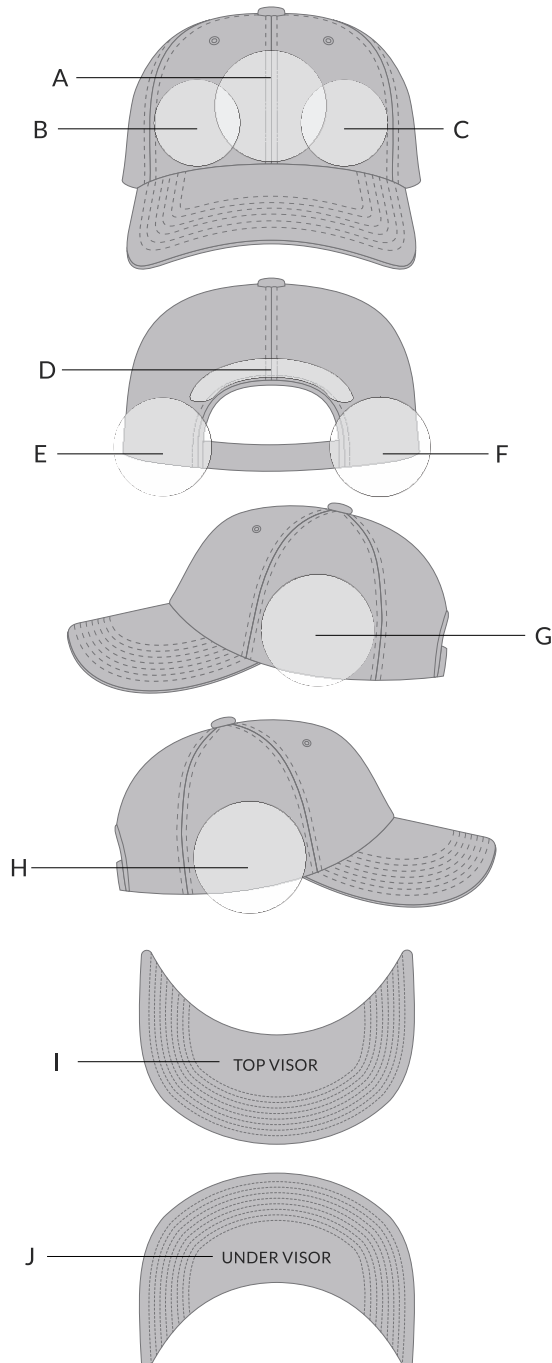

**DECORATION 1**

LOCATION (LETTER) \_\_\_\_\_

FILE NAME (ATTACH WEEMAIL) \_\_\_\_\_

SIZE (W x H) \_\_\_\_\_

COLOR(S) **COLORWAY 1 :** \_\_\_\_\_  
**COLORWAY 2 :** \_\_\_\_\_

EMBROIDERY       WOVEN LABEL  
 3D EMBROIDERY       WOVEN PATCH  
 FELT APPLIQUE       DEBOSSED LEATHER PATCH  
 SCREEN PRINT       EMBROIDERED PATCH  
 TWILL APPLIQUE       PRINTED PATCH

**NOTES**

**DECORATION 2**

LOCATION (LETTER) \_\_\_\_\_

FILE NAME (ATTACH WEEMAIL) \_\_\_\_\_

SIZE (W x H) \_\_\_\_\_

COLOR(S) **COLORWAY 1 :** \_\_\_\_\_  
**COLORWAY 2 :** \_\_\_\_\_

EMBROIDERY       WOVEN LABEL  
 3D EMBROIDERY       WOVEN PATCH  
 FELT APPLIQUE       DEBOSSED LEATHER PATCH  
 SCREEN PRINT       EMBROIDERED PATCH  
 TWILL APPLIQUE       PRINTED PATCH

**NOTES**

**DECORATION 3**

LOCATION (LETTER) \_\_\_\_\_

FILE NAME (ATTACH WEEMAIL) \_\_\_\_\_

SIZE (W x H) \_\_\_\_\_

COLOR(S) **COLORWAY 1 :** \_\_\_\_\_  
**COLORWAY 2 :** \_\_\_\_\_

EMBROIDERY       WOVEN LABEL  
 3D EMBROIDERY       WOVEN PATCH  
 FELT APPLIQUE       DEBOSSED LEATHER PATCH  
 SCREEN PRINT       EMBROIDERED PATCH  
 TWILL APPLIQUE       PRINTED PATCH

**NOTES**

**DECORATION 4**

LOCATION (LETTER) \_\_\_\_\_

FILE NAME (ATTACH WEEMAIL) \_\_\_\_\_

SIZE (W x H) \_\_\_\_\_

COLOR(S) **COLORWAY 1 :** \_\_\_\_\_  
**COLORWAY 2 :** \_\_\_\_\_

EMBROIDERY       WOVEN LABEL  
 3D EMBROIDERY       WOVEN PATCH  
 FELT APPLIQUE       DEBOSSED LEATHER PATCH  
 SCREEN PRINT       EMBROIDERED PATCH  
 TWILL APPLIQUE       PRINTED PATCH

**NOTES**

6 INTERNAL DECORATION + LABELING

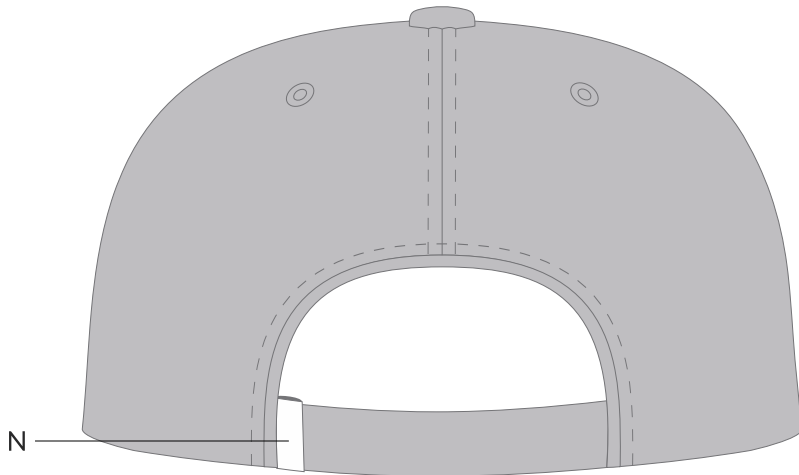
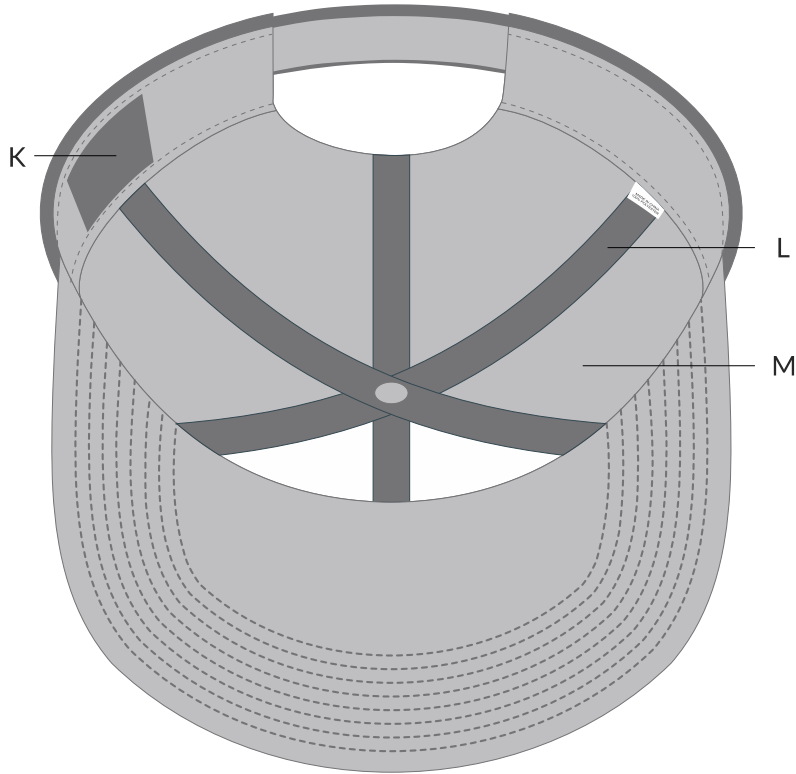

K - INTERNAL WOVEN LABEL



**PLEASE NOTE:** - MAX HEIGHT IS 25mm / .98"  
- MAX WIDTH IS 70mm / 2.75"  
- LABEL CAN BE PLACED ANYWHERE ON SWEATBAND

LABEL COLOR : \_\_\_\_\_

FILE NAME : \_\_\_\_\_  
(ATTACH W/EMAIL)

SIZE (W x H) : \_\_\_\_\_

NOTES :

L - SEAM TAPE

**PLEASE NOTE:** - SEAM TAPE IS 13mm TALL / .5" TALL  
- HEIGHT BETWEEN STITCHING IS -7mm / -.27" TALL



SEAM TAPE COLOR : \_\_\_\_\_

FILE NAME : \_\_\_\_\_  
(ATTACH W/EMAIL)

M - INNER LINING

NONE     CVC TWILL     TRICOT

INNER LINING COLOR : \_\_\_\_\_

**SCREEN PRINT**     YES     NO    FILE NAME : \_\_\_\_\_  
(ATTACH W/EMAIL)

N - BACKSTRAP WOVEN LABEL



**PLEASE NOTE:** - MAX HEIGHT IS 20mm / .98"  
- RECOMMENDED WIDTH IS 11mm - 15mm / .43" - .6"  
- LABEL CAN ONLY BE PLACED ON LEFT SIDE

LABEL COLOR : \_\_\_\_\_

FILE NAME : \_\_\_\_\_  
(ATTACH W/EMAIL)

SIZE (W x H) : \_\_\_\_\_

ADDITIONAL NOTES / DETAILS FOR CAP

\_\_\_\_\_

\_\_\_\_\_

\_\_\_\_\_

\_\_\_\_\_

\_\_\_\_\_

CAP TEMPLATES

ART REQUIREMENTS:

- PLEASE CONVERT TEXT TO OUTLINE
- PLEASE EXPAND ALL STROKES
- APPROPRIATE ART FILE TYPES ARE: AI, EPS, PDF

THIS PAGE IS OPTIONAL

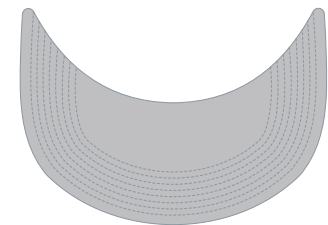
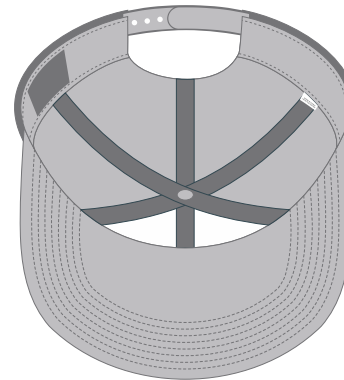
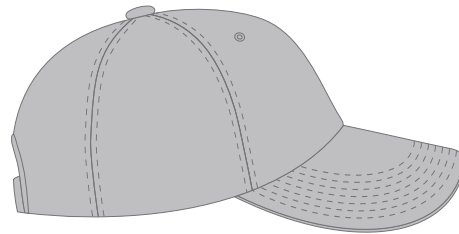
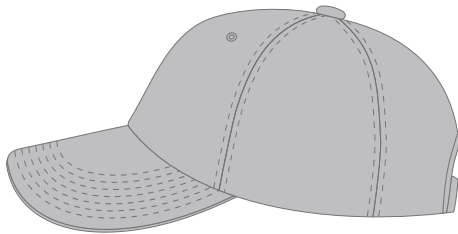
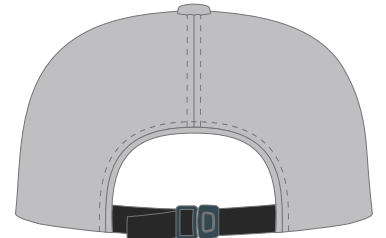
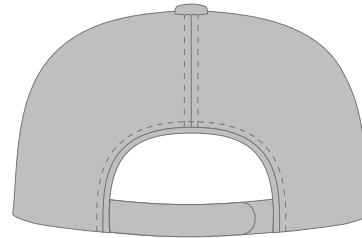
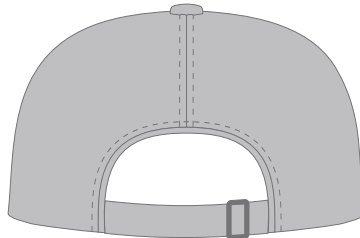
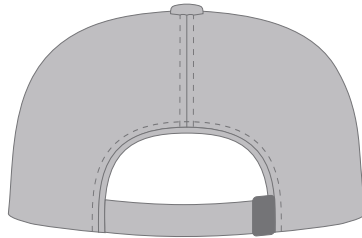
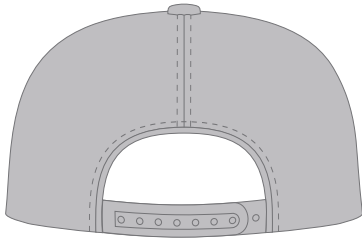

L - INTERNAL WOVEN LABEL



M - SEAM TAPE



O - BACKSTRAP WOVEN LABEL